

FUTURA ONE

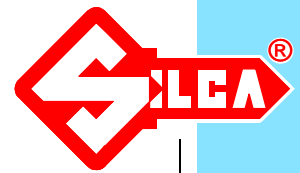

PER:
FOR:

ABUS (D)

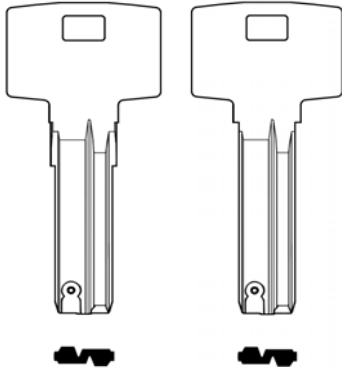

Bravus

(1000 - 2000 - 3000 - 4000)

System protected by a password issued by Silca on receipt of authorization.
Sistema protetto da password rilasciata da Silca a fronte di autorizzazione.
System geschützt durch von Silca geliefertes Password auf Genehmigung.
Système protégé par un password qui est émis par Silca sur autorisation.
Sistema protegido por password que expide Silca contra autorización.
Sistema protegido por uma password emitida por Silca contra a autorização.

OPTIONAL

D744315ZB



29J Jaw
Ganascia 29J
29J Backe
Mâchoire 29J
Quijada 29J
Garra 29J



OPTIONAL

D744317ZB



30J Jaw
Ganascia 30J
30J Backe
Mâchoire 30J
Quijada 30J
Garra 30J

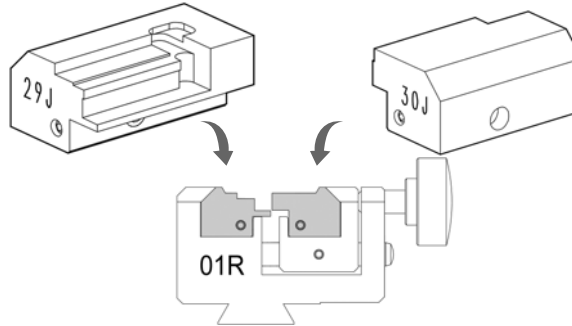

1000 - 2000 - 3000 systems

OPTIONAL



D744355ZB

Cutter 07D
Fresa 07D
Fräser 07D
Fraise 07D
Fresa 07D
Fresa 07D

4000 system

OPTIONAL



D744355ZB

Cutter 07D
Fresa 07D
Fräser 07D
Fraise 07D
Fresa 07D
Fresa 07D

OPTIONAL



D743672ZB

Cutter 03L
Fresa 03L
Fräser 03L
Fraise 03L
Fresa 03L
Fresa 03L

PER:
FOR:

ASSA (S)

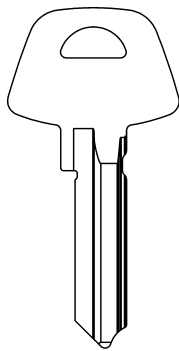

(D-12)

System protected by a password issued by Silca on receipt of authorization.
Sistema protetto da password rilasciata da Silca a fronte di autorizzazione.
System geschützt durch von Silca geliefertes Password auf Genehmigung.
Système protégé par un password qui est émis par Silca sur autorisation.
Sistema protegido por password que expide Silca contra autorización.
Sistema protegido por uma password emitida por Silca contra a autorização.

OPTIONAL

D744283ZB



20J Jaw
Ganascia 20J
20J Backe
Mâchoire 20J
Quijada 20J
Garra 20J



OPTIONAL

D744284ZB



21J Jaw
Ganascia 21J
21J Backe
Mâchoire 21J
Quijada 21J
Garra 21J

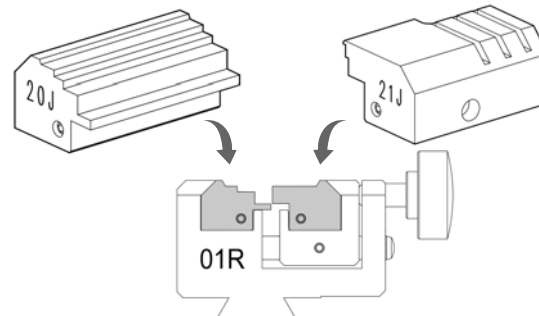

OPTIONAL



D743745ZB

Cutter 04L
Fresa 04L
Fräser 04L
Fraise 04L
Fresa 04L
Fresa 04L

Note: standard cutting is also required.
Nota: è necessaria anche la cifratura standard.
Hinweis: Standard Fräsung ist auch erforderlich.
Remarque: il faut aussi nécessaire le taillage standard.
Nota: también es necesario el corte estándar.
Observação: o corte standard es também necessário



PER:
FOR:

CISA (I)

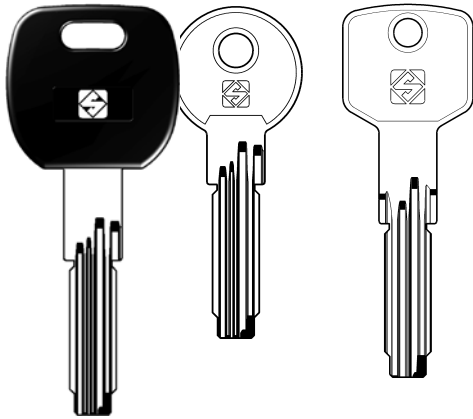

CS70P

CS70

CS62

ASTRAL
system 357

AB48
ABUS

OPTIONAL



D743261ZB

05J Jaw
Ganascia 05J
05J Backe
Mâchoire 05J
Quijada 05J
Garra 05J

D743262ZB

06J Jaw
Ganascia 06J
06J Backe
Mâchoire 06J
Quijada 06J
Garra 06J

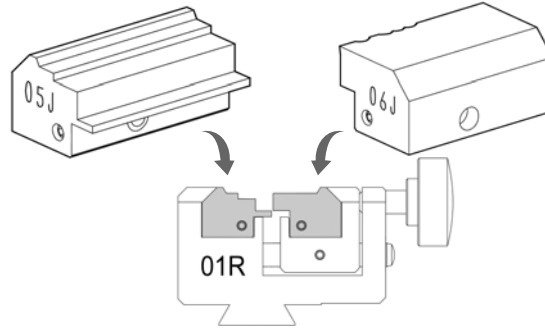

STANDARD



D742867ZB

Cutter 01D
Fresa 01D
Fräser 01D
Fraise 01D
Fresa 01D
Fresa 01D

ASTRAL system:

Codes tables protected by a password issued by Silca on receipt of the manufacturer's authorization.

Tabelle codici protette da password rilasciata da Silca a fronte di autorizzazione del costruttore.

Code-Tabellen geschützt durch von Silca geliefertes Password auf Herstellersgenehmigung.

Tables de codes protégées par un password qui est émis par Silca sur autorisation du Constructeur.

Tablas codigos protegidos por password que expide Silca contra autorización del constructor.

Tabelas de códigos protegidas por uma password emitida por Silca contra autorização do fabricante.

PER:
FOR:

DOM (D) CORBIN (I)

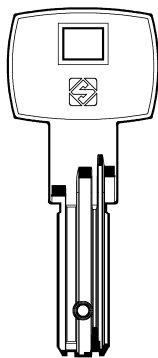

DM144

(IX6 KG Profile 121)

OPTIONAL



D743269ZB

09J Jaw
Ganascia 09J
09J Backe
Mâchoire 09J
Quijada 09J
Garra 09J

D743270ZB

10J Jaw
Ganascia 10J
10J Backe
Mâchoire 10J
Quijada 10J
Garra 10J

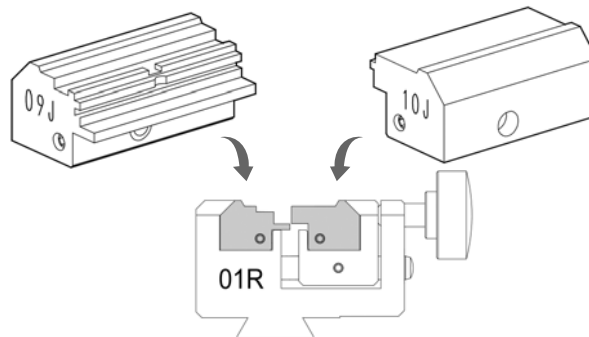

STANDARD



D742867ZB

Cutter 01D
Fresa 01D
Fräser 01D
Fraise 01D
Fresa 01D
Fresa 01D

PER:
FOR:

DOM (D)

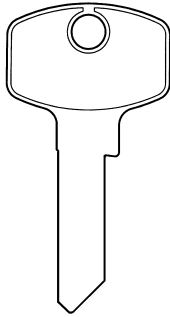

MM
(Prof. 145)

SIGMA

OPTIONAL

D744319ZB



31J Jaw
Ganascia 31J
31J Backe
Mâchoire 31J
Quijada 31J
Garra 31J

OPTIONAL D744321ZB



32J Jaw
Ganascia 32J
32J Backe
Mâchoire 32J
Quijada 32J
Garra 32J

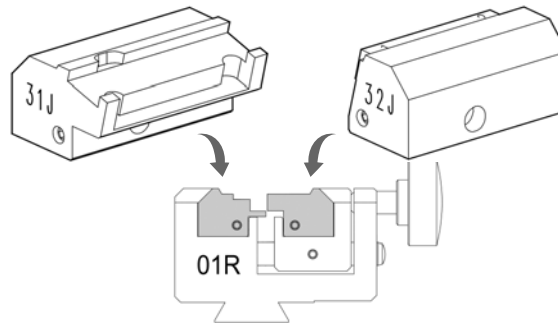

OPTIONAL



D744354ZB

Cutter 05D
Fresa 05D
Fräser 05D
Fraise 05D
Fresa 05D
Fresa 05D

*System protected by a password issued by Silca on receipt of authorization.
Sistema protetto da password rilasciata da Silca a fronte di autorizzazione.
System geschützt durch von Silca geliefertes Passwort auf Genehmigung.
Système protégé par un password qui est émis par Silca sur autorisation.
Sistema protegido por password que expide Silca contra autorización.
Sistema protegido por uma password emitida por Silca contra a autorização.*

*Note: standard cutting is also required.
Nota: è necessaria anche la cifratura standard.
Hinweis: Standard Fräsung ist auch erforderlich.
Remarque: il faut aussi nécessaire le taillage standard.
Nota: también es necesario el corte estándar.
Observação: o corte standard es também necessário*

PER:
FOR:

HUWIL (D)

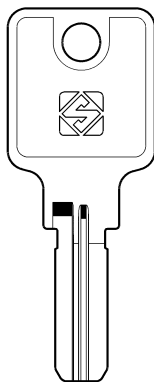

HW15R

OPTIONAL

D743362ZB



16J Jaw
Ganascia 16J
16J Backe
Mâchoire 16J
Quijada 16J
Garra 16J

D743365ZB

17J Jaw
Ganascia 17J
17J Backe
Mâchoire 17J
Quijada 17J
Garra 17J

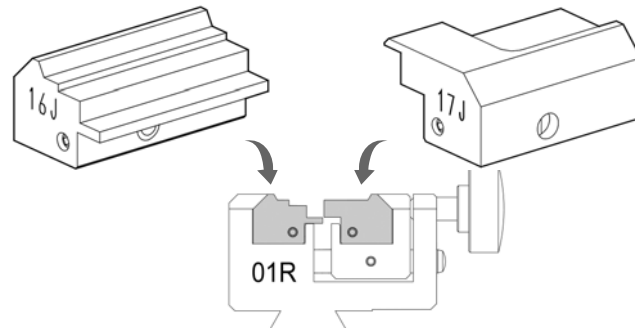

STANDARD



D742606ZB

Cutter 01L
Fresa 01L
Fräser 01L
Fraise 01L
Fresa 01L
Fresa 01L

FUTURA ONE

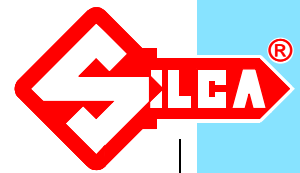

PER:
FOR:

ISEO (I)

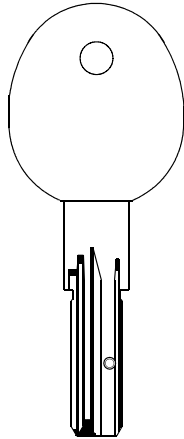

(ISR100 WEB / R100 / R50)

OPTIONAL

D743278ZB

11J Jaw
Ganascia 11J
11J Backe
Mâchoire 11J
Quijada 11J
Garra 11J



STANDARD D943254ZR

02J Jaw
Ganascia 02J
02J Backe
Mâchoire 02J
Quijada 02J
Garra 02J

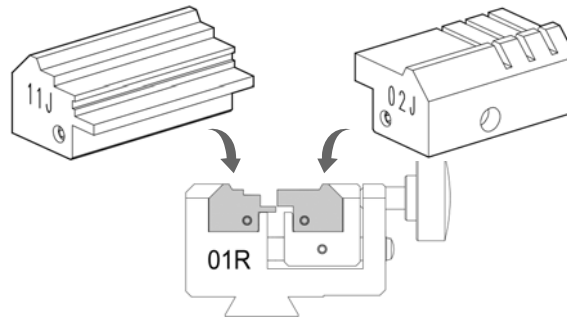

STANDARD

D742867ZB

Cutter 01D
Fresa 01D
Fräser 01D
Fraïse 01D
Fresa 01D
Fresa 01D



Codes tables protected by a password issued by Silca on receipt of the manufacturer's authorization.

Tabella codici protette da password rilasciata da Silca a fronte di autorizzazione del costruttore.

Code-Tabellen geschützt durch von Silca geliefertes Passwort auf Herstellersgenehmigung.

Tables de codes protégées par un password qui est émis par Silca sur autorisation du Constructeur.

Tablas codigos protegidos por password que expide Silca contra autorización del constructor.

Tabelas de códigos protegidas por uma password emitida por Silca contra autorização do fabricante.

PER:
FOR:

KABA (CH)



maTrix
(K59)

OPTIONAL

D744295ZB

33J Jaw
Ganascia 33J
33J Backe
Mâchoire 33J
Quijada 33J
Garra 33J



OPTIONAL

D744296ZB

34J Jaw
Ganascia 34J
34J Backe
Mâchoire 34J
Quijada 34J
Garra 34J

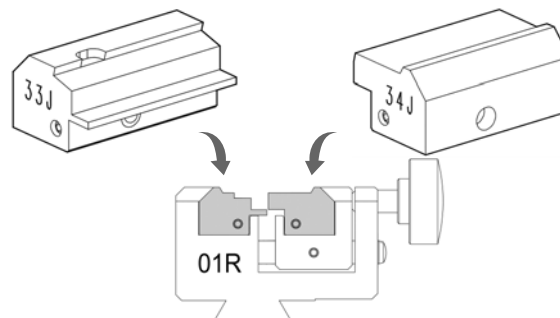

STANDARD

D742867ZB

Cutter 01D
Fresa 01D
Fräser 01D
Fraïse 01D
Fresa 01D
Fresa 01D



FUTURA ONE



PER:
FOR:

KABA (CH)

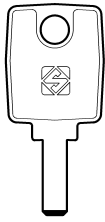

KA8
(KABA-MICRO)

OPTIONAL



D729845ZB

A18 adapter
Adattatore A18
Adapter A18
Adaptateur A18
Adaptador A18
Adaptador A18

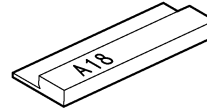

STANDARD



D943253ZR

01J Jaw
Ganascia 01J
01J Backe
Mâchoire 01J
Quijada 01J
Garra 01J

D943254ZR

02J Jaw
Ganascia 02J
02J Backe
Mâchoire 02J
Quijada 02J
Garra 02J

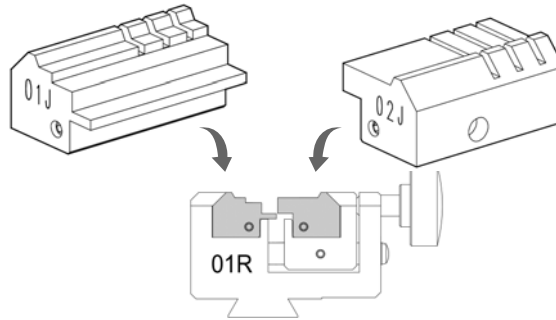

OPTIONAL



D743674ZB

Cutter 03D
Fresa 03D
Fräser 03D
Fraise 03D
Fresa 03D
Fresa 03D

PER:
FOR:

KESO (CH)

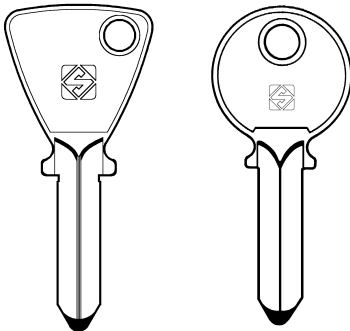

KE1

KE2

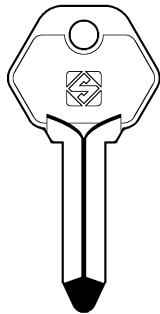

KE4

(1000 System)

OPTIONAL



D744291ZB

26J Jaw
Ganascia 26J
26J Backe
Mâchoire 26J
Quijada 26J
Garra 26J

OPTIONAL



D744292ZB

27J Jaw
Ganascia 27J
27J Backe
Mâchoire 27J
Quijada 27J
Garra 27J

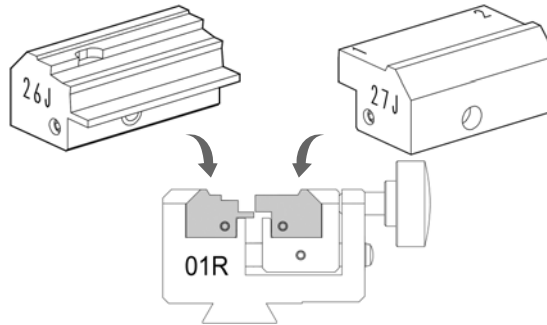

STANDARD



D742867ZB

Cutter 01D
Fresa 01D
Fräser 01D
Fraise 01D
Fresa 01D
Fresa 01D

OPTIONAL



D743674ZB

Cutter 03D
Fresa 03D
Fräser 03D
Fraise 03D
Fresa 03D
Fresa 03D



PER:
FOR:

KYR (I)

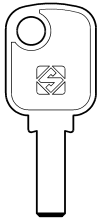

SCU1
SECURITAL

OPTIONAL



D729845ZB

A18 adapter
Adattatore A18
Adapter A18
Adaptateur A18
Adaptador A18
Adaptador A18

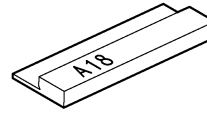

STANDARD



D943253ZR

01J Jaw
Ganascia 01J
01J Backe
Mâchoire 01J
Quijada 01J
Garra 01J

D943254ZR

02J Jaw
Ganascia 02J
02J Backe
Mâchoire 02J
Quijada 02J
Garra 02J

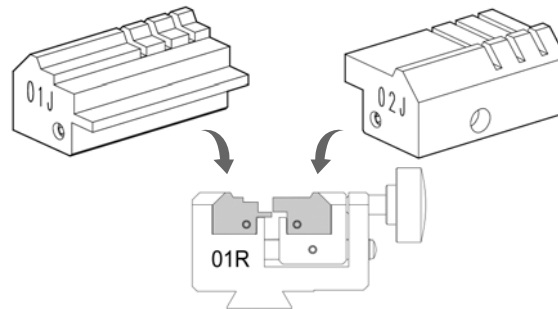

STANDARD



D742867ZB

Cutter 01D
Fresa 01D
Fräser 01D
Fraise 01D
Fresa 01D
Fresa 01D

PER:
FOR:

MERONI (I)

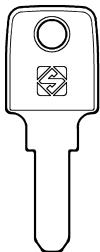

MER39
M4

OPTIONAL



D743343ZB

14J Jaw
Ganascia 14J
14J Backe
Mâchoire 14J
Quijada 14J
Garra 14J

D743361ZB

15J Jaw
Ganascia 15J
15J Backe
Mâchoire 15J
Quijada 15J
Garra 15J

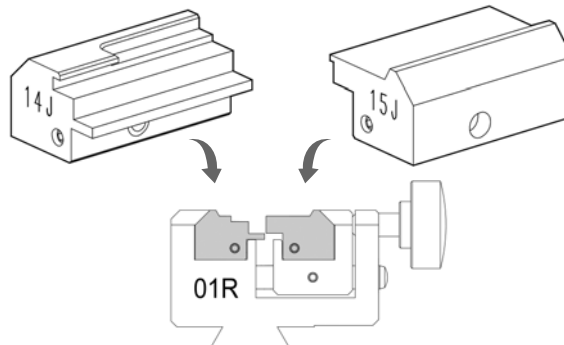

OPTIONAL



D743671ZB

Cutter 02L
Fresa 02L
Fräser 02L
Fraise 02L
Fresa 02L
Fresa 02L

FUTURA ONE

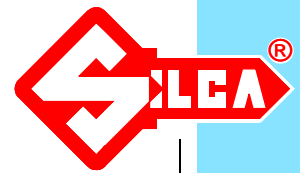

PER:
FOR:

MAGNUM (GB)

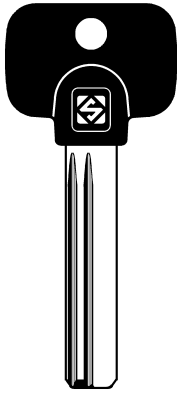

MGN1RP

Magnum Superior
(5+4) (4+3) (3+2)

Magnum Superior +
(5+4) (4+3) (3+2)

OPTIONAL D744363ZB



35J Jaw
Ganascia 35J
35J Backe
Mâchoire 35J
Quijada 35J
Garra 35J

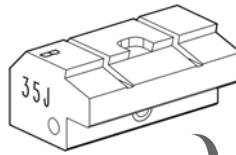

OPTIONAL D744365ZB



36J Jaw
Ganascia 36J
36J Backe
Mâchoire 36J
Quijada 36J
Garra 36J

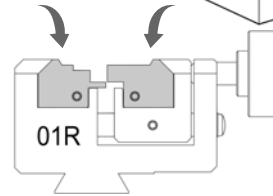
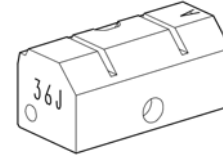

OPTIONAL



D743673ZB

Cutter 02D
Fresa 02D
Fräser 02D
Fraise 02D
Fresa 02D
Fresa 02D

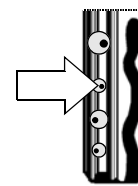

STANDARD D943253ZR



01J Jaw
Ganascia 01J
01J Backe
Mâchoire 01J
Quijada 01J
Garra 01J

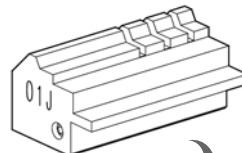

STANDARD D943254ZR



02J Jaw
Ganascia 02J
02J Backe
Mâchoire 02J
Quijada 02J
Garra 02J

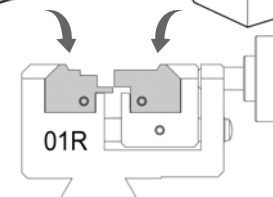
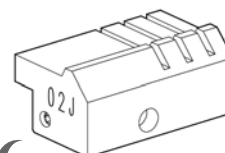

OPTIONAL



D743745ZB

Cutter 04L
Fresa 04L
Fräser 04L
Fraise 04L
Fresa 04L
Fresa 04L

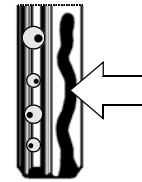

PER:
FOR: **PFAFFENHAIN (D)**

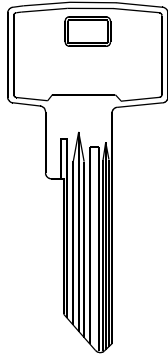

(K14)

OPTIONAL D744309ZB
 24J Jaw
 Ganascia 24J
 24J Backe
 Mâchoire 24J
 Quijada 24J
 Garra 24J



OPTIONAL D744311ZB
 25J Jaw
 Ganascia 25J
 25J Backe
 Mâchoire 25J
 Quijada 25J
 Garra 25J

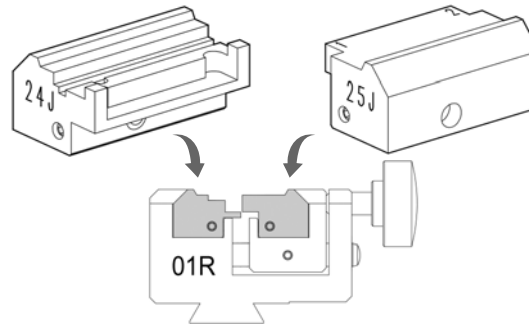

STANDARD D742867ZB
 Cutter 01D
 Fresa 01D
 Fräser 01D
 Fraise 01D
 Fresa 01D
 Fresa 01D



Note: standard cutting is also required.
Nota: è necessaria anche la cifratura standard.
Hinweis: Standard Fräsung ist auch erforderlich.
Remarque: il faut aussi nécessaire le taillage standard.
Nota: también es necesario el corte estándar.
Observação: o corte standard es também necessário

PER:
FOR: **PFAFFENHAIN (D)**

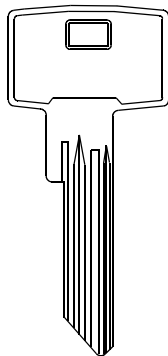

(KV14 - XY14)
(KV14 - XV14)

OPTIONAL D744313ZB
 28J Jaw
 Ganascia 28J
 28J Backe
 Mâchoire 28J
 Quijada 28J
 Garra 28J



OPTIONAL D744311ZB
 25J Jaw
 Ganascia 25J
 25J Backe
 Mâchoire 25J
 Quijada 25J
 Garra 25J

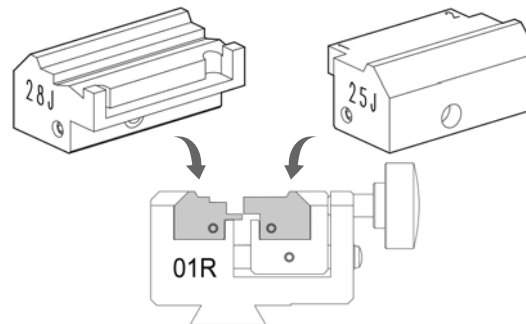

STANDARD D742867ZB
 Cutter 01D
 Fresa 01D
 Fräser 01D
 Fraise 01D
 Fresa 01D
 Fresa 01D



Note: standard cutting is also required.
Nota: è necessaria anche la cifratura standard.
Hinweis: Standard Fräsung ist auch erforderlich.
Remarque: il faut aussi nécessaire le taillage standard.
Nota: también es necesario el corte estándar.
Observação: o corte standard es também necessário

FUTURA ONE

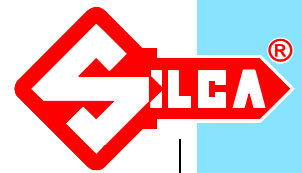

PER:
FOR:

SECUREMME (I)

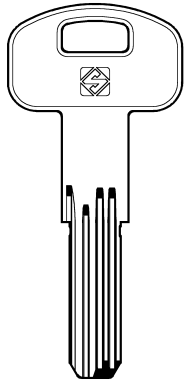

SCM2
K1

OPTIONAL



D743341ZB

13J Jaw
Ganascia 13J
13J Backe
Mâchoire 13J
Quijada 13J
Garra 13J

STANDARD



D943254ZR

02J Jaw
Ganascia 02J
02J Backe
Mâchoire 02J
Quijada 02J
Garra 02J

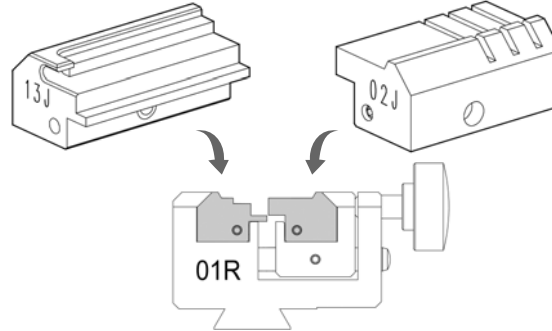

OPTIONAL



D743673ZB

Cutter 02D
Fresa 02D
Fräser 02D
Fraise 02D
Fresa 02D
Fresa 02D

PER:
FOR:

SECUREMME (I)

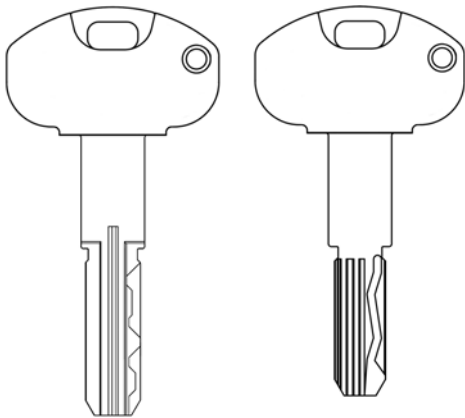

(K3)
5 pin

(K3)
5+5 pin

OPTIONAL



D743261ZB

05J Jaw
Ganascia 05J
05J Backe
Mâchoire 05J
Quijada 05J
Garra 05J

D743262ZB

06J Jaw
Ganascia 06J
06J Backe
Mâchoire 06J
Quijada 06J
Garra 06J

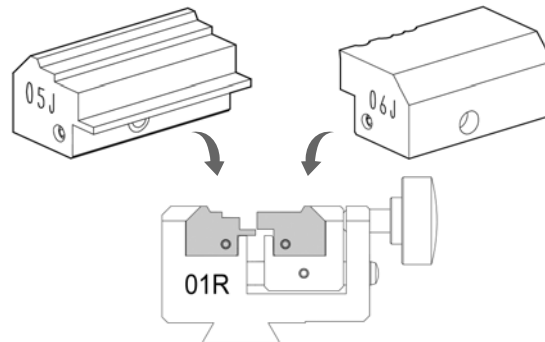

OPTIONAL



D743673ZB

Cutter 02D
Fresa 02D
Fräser 02D
Fraise 02D
Fresa 02D
Fresa 02D



PER:
FOR:

SECUREMME (I)

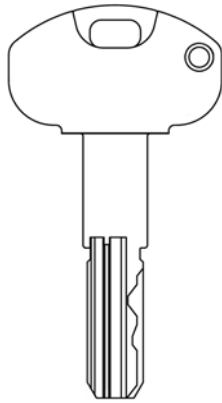

(K5)

6 pin

OPTIONAL



D744017ZB

18J Jaw
Ganascia 18J
18J Backe
Mâchoire 18J
Quijada 18J
Garra 18J

STANDARD



D943254ZR

02J Jaw
Ganascia 02J
02J Backe
Mâchoire 02J
Quijada 02J
Garra 02J

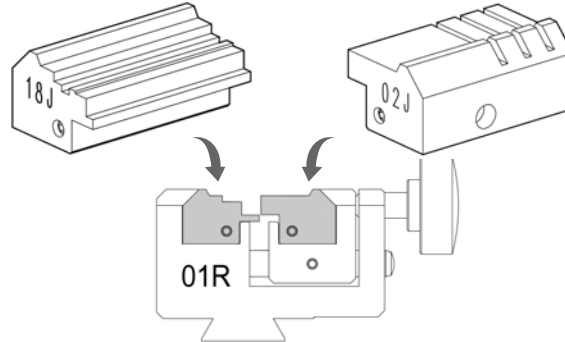

OPTIONAL



D743673ZB

Cutter 02D
Fresa 02D
Fräser 02D
Fraise 02D
Fresa 02D
Fresa 02D

*System protected by a password issued by Silca on receipt of authorization.
Sistema protetto da password rilasciata da Silca a fronte di autorizzazione.
System geschützt durch von Silca geliefertes Passwort auf Genehmigung.
Système protégé par un password qui est émis par Silca sur autorisation.
Sistema protegido por password que expide Silca contra autorización.
Sistema protegido por uma password emitida por Silca contra a autorização.*

PER:
FOR:

STS (E)

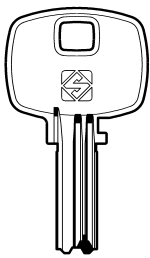

STS5

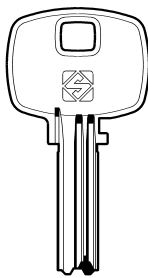

STS6

OPTIONAL



D743340ZB

12J Jaw
Ganascia 12J
12J Backe
Mâchoire 12J
Quijada 12J
Garra 12J

STANDARD



D943254ZR

02J Jaw
Ganascia 02J
02J Backe
Mâchoire 02J
Quijada 02J
Garra 02J

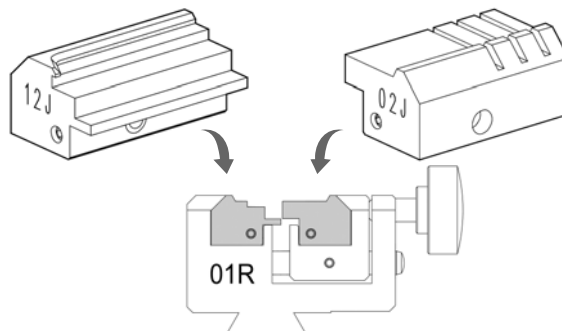

STANDARD



D742867ZB

Cutter 01D
Fresa 01D
Fräser 01D
Fraise 01D
Fresa 01D
Fresa 01D

PER:
FOR:

VACHETTE (F)

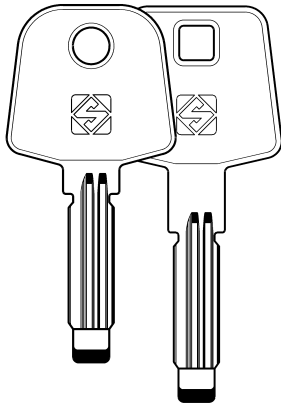

VAC91 VAC104
 VAC103 VAC105

(VACHETTE RADIAL)

OPTIONAL

D744287ZB

22J Jaw
Ganascia 22J
22J Backe
Mâchoire 22J
Quijada 22J
Garra 22J



OPTIONAL

D744288ZB

23J Jaw
Ganascia 23J
23J Backe
Mâchoire 23J
Quijada 23J
Garra 23J

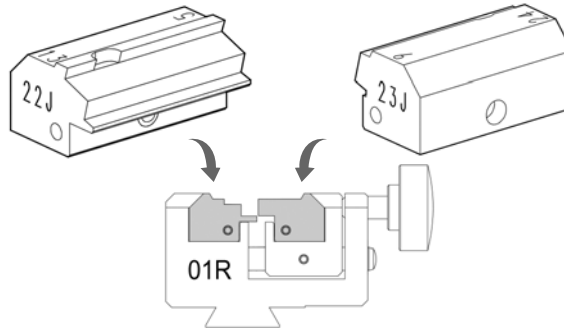

OPTIONAL

D743674ZB

Cutter 03D
Fresa 03D
Fräser 03D
Fraise 03D
Fresa 03D
Fresa 03D



PER:
FOR:

WINKHAUS (D)

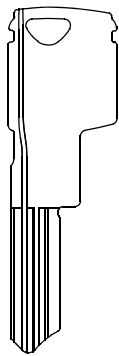

(RPE - RPS)

OPTIONAL

D744309ZB

24J Jaw
Ganascia 24J
24J Backe
Mâchoire 24J
Quijada 24J
Garra 24J



OPTIONAL

D744311ZB

25J Jaw
Ganascia 25J
25J Backe
Mâchoire 25J
Quijada 25J
Garra 25J

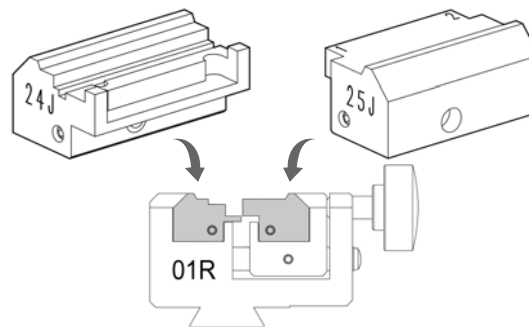

OPTIONAL

D744353ZB

Cutter 06D
Fresa 06D
Fräser 06D
Fraise 06D
Fresa 06D
Fresa 06D



System protected by a password issued by Silca on receipt of authorization.

Sistema protetto da password rilasciata da Silca a fronte di autorizzazione.

System geschützt durch von Silca geliefertes Password auf Genehmigung.

Système protégé par un password qui est émis par Silca sur autorisation.

Sistema protegido por password que expide Silca contra autorización.

Sistema protegido por uma password emitida por Silca contra a autorização.

Note: standard cutting is also required.
Nota: è necessaria anche la cifratura standard.
Hinweis: Standard Fräsung ist auch erforderlich.
Remarque: il faut aussi nécessaire le taillage standard.
Nota: también es necesario el corte estándar.
Observação: o corte standard es também necessário

FUTURA ONE



PER:
FOR:

AUDI (D)
FORD (D)
PORSCHE (D)
SEAT (E)
SKODA (CZ)
VOLKSWAGEN (D)



HU66MH	HU66P	HU66AT5 HU66AT6
HU66EHP	HU66T5 HU66T6	
HU66FH	HU66T10	HU66CT5
HU75T	HU66T15	HU66DT5
	HU66T23	HU66CT6
	HU66T26	HU66BT1
	HU66T28	HU66BT15
	HU66TE	HU66BT28

HUF (D) - WITTE (D)

OPTIONAL



D744023ZB

19J Jaw
Ganascia 19J
19J Backe
Mâchoire 19J
Quijada 19J
Garra 19J

STANDARD



D943254ZR

02J Jaw
Ganascia 02J
02J Backe
Mâchoire 02J
Quijada 02J
Garra 02J

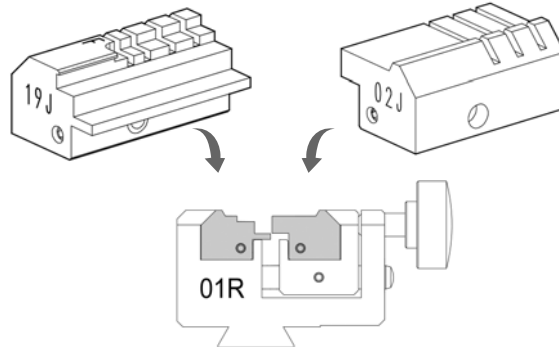

STANDARD



D742606ZB

Cutter 01L
Fresa 01L
Fräser 01L
Fraise 01L
Fresa 01L
Fresa 01L

PER:
FOR:

BMW (D)

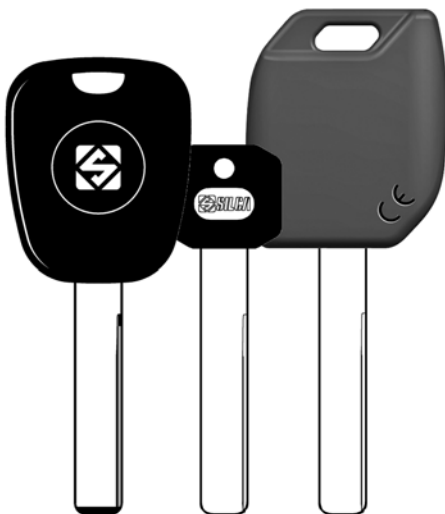

HU92RP HU92RKP HU92RMH

STANDARD



D943253ZR

01J Jaw
Ganascia 01J
01J Backe
Mâchoire 01J
Quijada 01J
Garra 01J

OPTIONAL



D743256ZB

04J Jaw
Ganascia 04J
04J Backe
Mâchoire 04J
Quijada 04J
Garra 04J

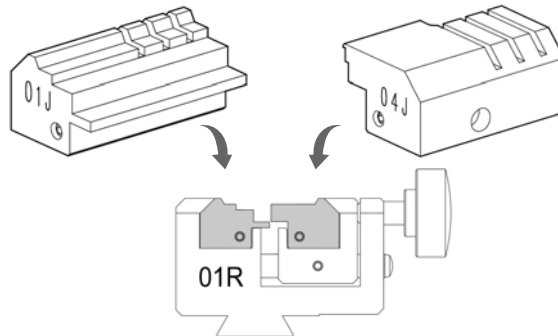

STANDARD



D742606ZB

Cutter 01L
Fresa 01L
Fräser 01L
Fraise 01L
Fresa 01L
Fresa 01L



FUTURA ONE

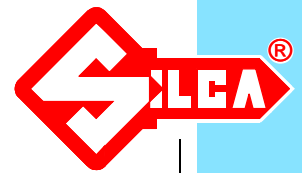

PER:
FOR:

FORD (D)

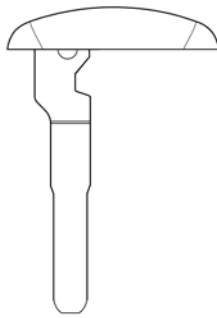

(Escape model)

OPTIONAL



D741485ZB

A34 adapter
Adattatore A34
Adapter A34
Adaptateur A34
Adaptador A34
Adaptador A34

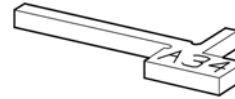

STANDARD



D943253ZR

01J Jaw
Ganascia 01J
01J Backe
Mâchoire 01J
Quijada 01J
Garra 01J

STANDARD



D943254ZR

02J Jaw
Ganascia 02J
02J Backe
Mâchoire 02J
Quijada 02J
Garra 02J

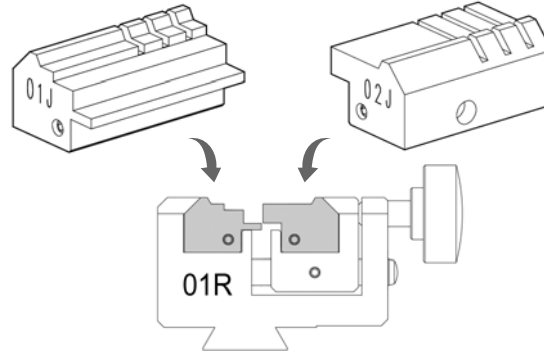

STANDARD



D742606ZB

Cutter 01L
Fresa 01L
Fräser 01L
Fraise 01L
Fresa 01L
Fresa 01L

OR

OPTIONAL



D744023ZB

19J Jaw
Ganascia 19J
19J Backe
Mâchoire 19J
Quijada 19J
Garra 19J

STANDARD



D943254ZR

02J Jaw
Ganascia 02J
02J Backe
Mâchoire 02J
Quijada 02J
Garra 02J

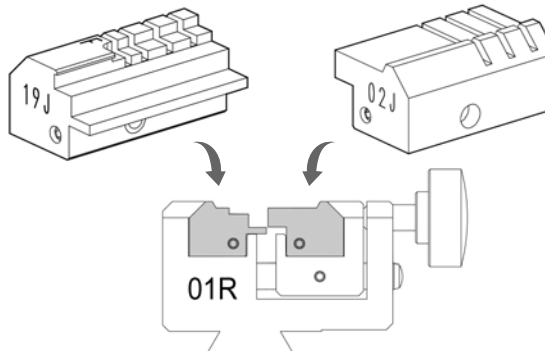

STANDARD



D742606ZB

Cutter 01L
Fresa 01L
Fräser 01L
Fraise 01L
Fresa 01L
Fresa 01L



FUTURA ONE

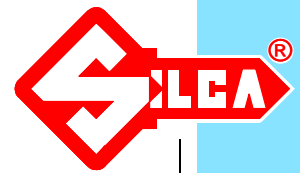

PER: **FORD (EU+USA)**
FOR:

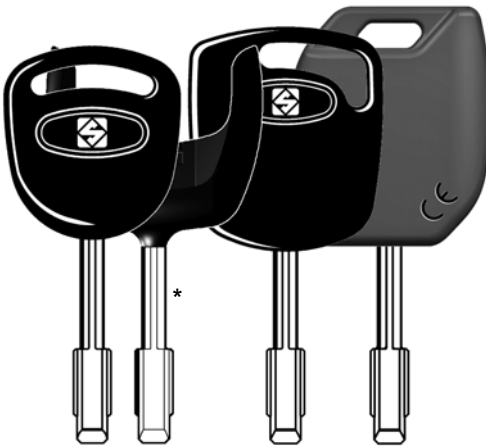

FO21P FO21AP FO21T3 FO21MH
FO21T3M
FO21T7
FO21T17
FO21TE
FO21FH

FO21EH1
FO21EH2

** IMPORTANT! Key blank to be applied to the original remote control (the remote control includes the transponder chip)*

TIBBE (D)
VALEO (F)

OPTIONAL



D743276ZB
03R Clamp
Morsetto 03R
03R Spannbacke
Etau 03R
Mordaza 03R
Mordente 03R

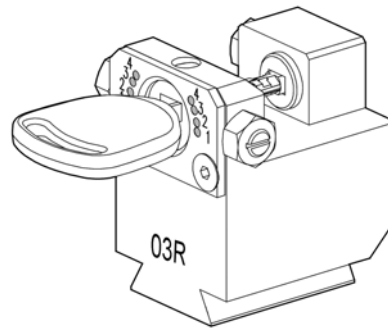

STANDARD



D742606ZB
Cutter 01L
Fresa 01L
Fräser 01L
Fraise 01L
Fresa 01L
Fresa 01L

PER: **HUF (D)**
FOR:

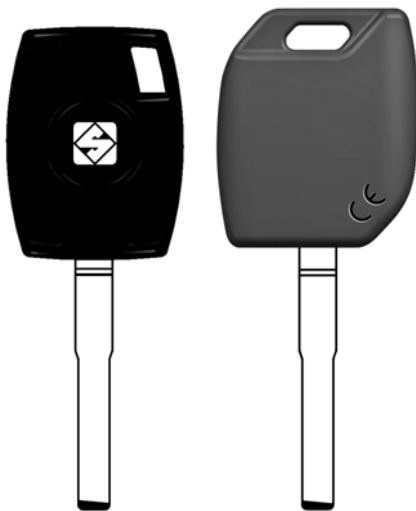

HU101T17
HU101T20
HU101TE

HU101MH

HU101T
HU101AP
HU101EH
HU101FH

OPTIONAL



D744023ZB
19J Jaw
Ganascia 19J
19J Backe
Mâchoire 19J
Quijada 19J
Garra 19J

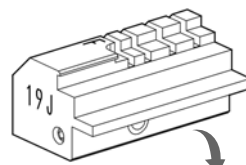

STANDARD



D943254ZR
02J Jaw
Ganascia 02J
02J Backe
Mâchoire 02J
Quijada 02J
Garra 02J

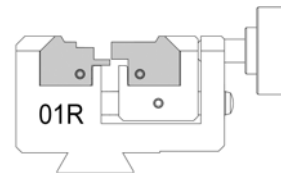
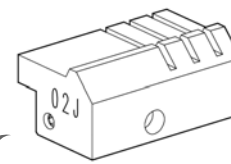

STANDARD



D742606ZB
Cutter 01L
Fresa 01L
Fräser 01L
Fraise 01L
Fresa 01L
Fresa 01L



FUTURA ONE

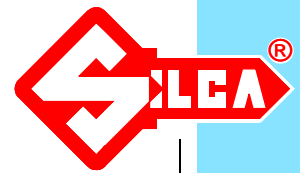

PER:
FOR:

MERCEDES (D)



HU41P

HU55P

HU64P

HU61AP

HU64T

HU65AP

HUF (D)

STANDARD



D943253ZR

01J Jaw
Ganascia 01J
01J Backe
Mâchoire 01J
Quijada 01J
Garra 01J

OPTIONAL



D743256ZB

04J Jaw
Ganascia 04J
04J Backe
Mâchoire 04J
Quijada 04J
Garra 04J

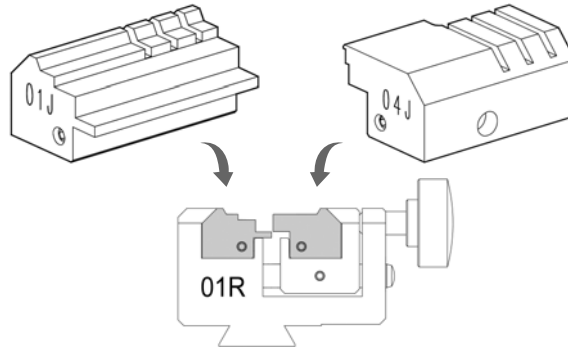

STANDARD



D742606ZB

Cutter 01L
Fresa 01L
Fräser 01L
Fraise 01L
Fresa 01L
Fresa 01L

PER:
FOR:

TUBULAR KEYS CHIAVI TUBOLARI STECKSCHLÜSSEL CLÉS TUBULAIRES LLAVES TUBOLARES

AGA (E)
BILMA (E)

BIL1T

CHICAGO (USA)

CH9T
CH16T (9.2)
CH17T (10)

L&F (GB)
KENSTAN (USA)

CH9T

MERONI (I)

MER22T (9.50)
MER25T (9.50)

P.CORTELLEZZI (I)

PC12T (9.60)
PC12TP (9.60)
PC15T (9.60)
PC15TP (9.60)

SILCA (I)

SLC1TP (9.60)
SLC2TP (9.60)

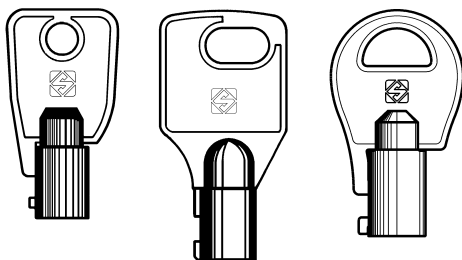

CH9T

MER22T

BIL1T

OPTIONAL



D743275ZB

02R Clamp
Morsetto 02R
02R Spannbacke
Etau 02R
Mordaza 02R
Mordente 02R

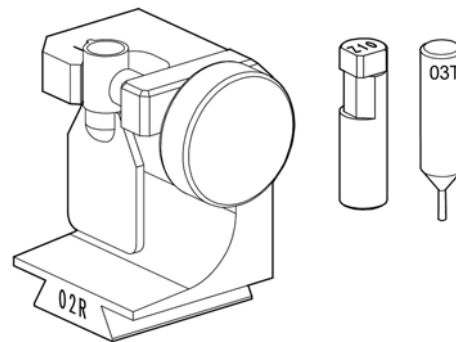

OPTIONAL



D743672ZB

Cutter 03L
Fresa 03L
Fräser 03L
Fraise 03L
Fresa 03L
Fresa 03L

